

We ensure that systems work better.

VULKAN

Marine

Hybrid and electric drive solutions

Hybrid propulsion solutions for new building and retrofit projects.





CONTENTS

The Team Who we are	05	Reference Projects	14	Reference Project Benetti B.Yond Product supply Installation Service	26
What we offer Different scopes of supply for different, unique projects	07	Reference Project The BIIM Product supply Installation Service	14	On the way to maritime energy transition	28
Hybrid solutions for all kind of vessels Serial and parallel hybrid	08	Reference Project ACTV Project Motobatello 3 Series 80 canal grande ACTV The Retrofit	18	VULKAN Group System supplier and consultant for hybrid propulsion	30
Hybrid drives by VULKAN VHD (Vulkan Hybrid Drive) Operation modes Power Flows	10	Reference Project Quinta Essentia Mechanical design and integration Product supply Installation Service	22	Service you can trust Worldwide and all around the clock	34
Hybrid drives by VULKAN H Series	12	Reference Project Tankoa Binta d'Or Mechanical design and integration Product supply Service	24	After Sales Service Complete competence for your System	35



Discover green sailing with VULKAN Hybrid Architect

#sustainability #greensailing

Our competitive
Your dream
reality.

VULKAN

VULKAN

VULKAN

VULKAN

VULKAN



THE TEAM | WHO WE ARE

WE DESIGN YOUR HYBRID DRIVE SYSTEM

Hybrid Architect is the VULKAN division engaged with sustainable and innovative propulsion systems.

WE ARE

- ⌚ **Flexible** – we can be designers, suppliers, integrators, service providers or all-in-one, depending on project and customer's request
- ⌚ **Customer oriented** – we listen to our customers. We design and supply hybrid propulsion systems best suited to the vessel's type and relevant operating profile
- ⌚ **A multi-disciplinary team** – we are an international company with wide-ranging expertise (mechanical, electrical, software, integration, project management and service skills)
- ⌚ **International** – the Hybrid Architect Team is mainly based in Italy and interacts with all VULKAN companies
- ⌚ **A Smart** – young, well-coordinated team, with many years of intensive collaboration
- ⌚ **Experts** – we have designed and supplied many systems for different applications



The Hybrid Architect Team looks forward to your enquiry

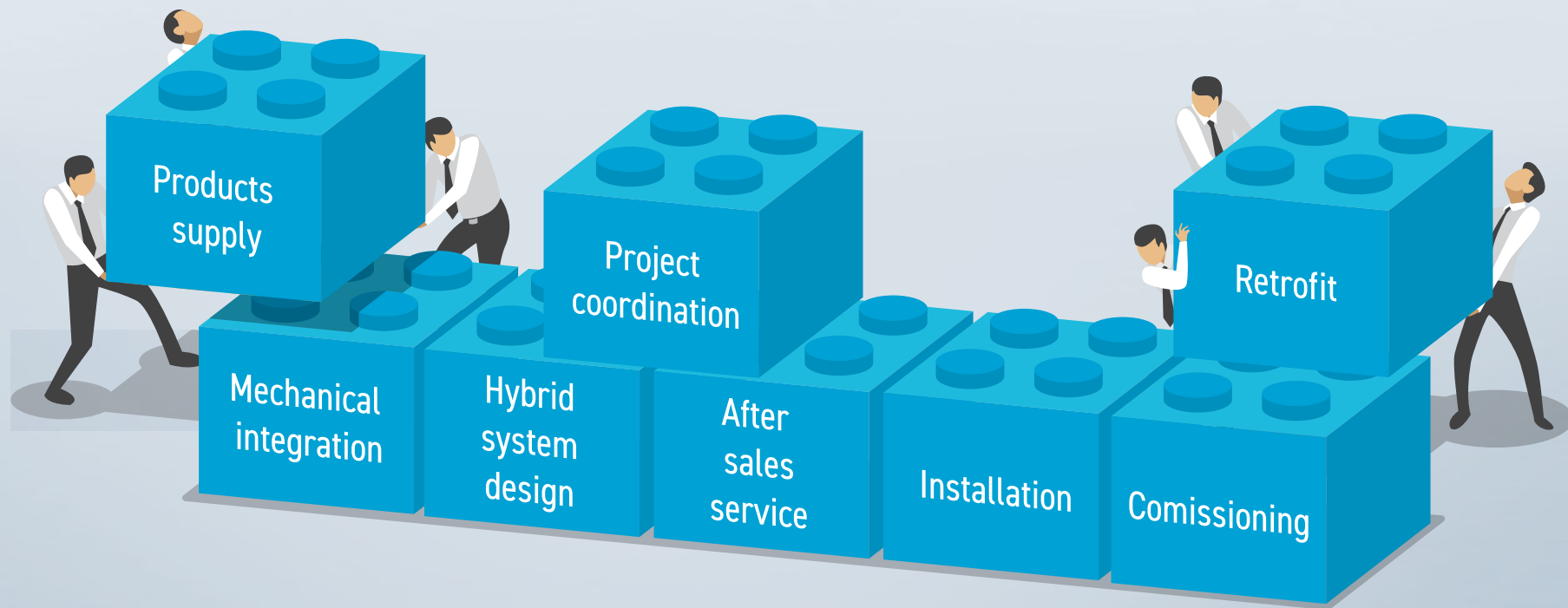

WHAT WE OFFER



DIFFERENT SCOPES OF SUPPLY FOR UNIQUE PROJECTS

EACH ACTIVITY IS PART OF THE PUZZLE

More than just flexible

This has been VULKAN's motto since the beginning of our foundation in 1889. Since then we haven't been „only“ a coupling supplier. This is even more true for the design of hybrid drives. There is no single formula, but a variety of solutions. It depends on the customer and his specific requirements, the type and use of the vessel. That is why we are able to offer different levels of support. And you are free to choose the one that suits you best. The first is a „simple“ design activity.

We study the project, listen to the owner's requirements, understand the needs and propose our solution. The second level is a bit more demanding: We can also provide certain components of the system. There is a third level where we take full responsibility. The customer outsources everything to us (the design and full supply) and we take care of the whole process of developing the hybrid system, buying all the necessary components and assembling them together to make the system work perfectly.



The Hybrid Architect Team during the installation of the salt batteries



Wire rope mounts are installed to preserve electronic components on board.



Last adjustment before the launch of our first retrofit ACTV project

HYBRID SOLUTIONS FOR ALL KIND OF VESSELS



SERIAL AND PARALLEL HYBRID

Yacht – Parallel hybrid drive



Workboat – Parallel hybrid drive

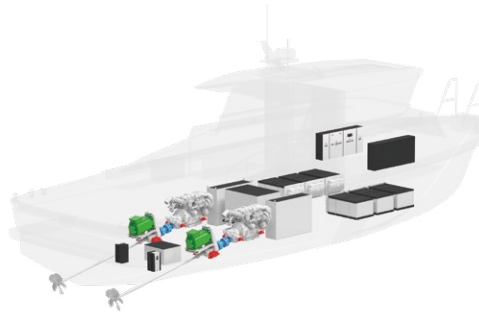

Windfarmvessel – Parallel Hybrid drive

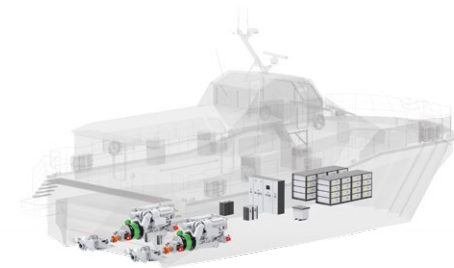

Passanger Ferry – Serial hybrid drive

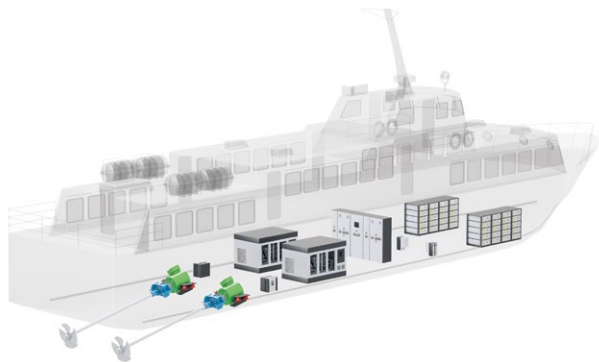

Pusher Tug – Full electric

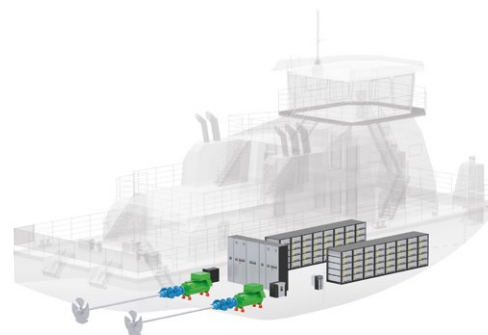

Longliner fishing vessel – Parallel Hybrid drive

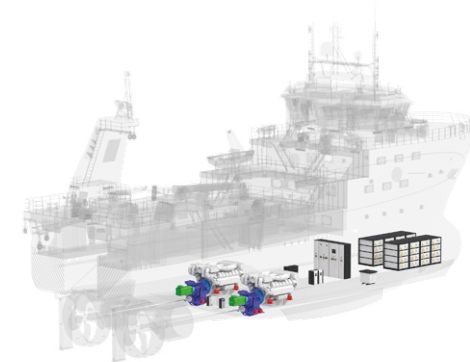

HYBRID SOLUTIONS FOR ALL KIND OF VESSELS



SERIAL AND PARALLEL HYBRID

FOCUS ON SERIAL HYBRID PROPULSION



What is it?

A serial hybrid system involves the production of electric power from a diesel engine coupled to a generator: in combination with an energy storage system (batteries), the generator gives power to the electric motor, the only component connected to the propeller.

HOW TO UTILIZE IT BEST?

Advantages:

The first advantage of a **serial hybrid propulsion system** is offering significant flexibility to the propulsion system, optimizing the diesel engines' performance, improving their efficiency. This flexibility is due to the complete separation between energy sources and users, allowing for **more efficient energy management**. Providing greater independence to the primary power source, the diesel engine, mechanically decoupling it from the propulsion line, also contributes to a higher level of **comfort** on board, significantly reducing **noise and vibrations**.

Disadvantages:

However, adopting this type of propulsion has a considerable impact on the overall vessel cost: The more complex the system, the higher the level of design required to make it as complete and efficient as possible, and in line with the vessel's needs and requirements. The initial investment will thus be higher compared to traditional propulsion. On the other hand, retrofitting a traditional propulsion with a hybrid one is a brilliant example of applying circular economy principles, reusing everything possible already installed on board, integrating it into the new design, thus is reducing the environmental impact and making it even more sustainable.

FOCUS ON PARALLEL HYBRID PROPULSION



What is it?

In a parallel hybrid propulsion systems the diesel engine and the electric motor are connected to the propeller. The vessel could then be propelled purely by the diesel engine, purely by the electric motor, or by a combination of both.

VARIETY OF SOLUTIONS FOR DIFFERENT GOALS

Advantages:

Compactness and lightness are perfect for limited spaces the robustness and reliability of the system ensure consistent performance over time. Thanks to modularity, obtained through the standardization of hybrid components, and advanced electrical design safety, compliant with the highest industrial standards, an additional safety level is added. Customization allows for tailor-made solutions, combining diesel engines of various powers with electric motors suitable for the specific needs of the project and customer; package's flexibility makes it ideal for both, pleasure and commercial vessels.

Disadvantages:

On the other hand, the parallel configuration (with „secondary shaft“) is characterized by greater flexibility in managing the reduction ratio between the electric machine and the propeller shaft, optimizing the propulsion system's efficiency. Such a configuration will consequently have a greater overall weight, due to the use of an additional mechanical transmission, as well as an electric motor. This affects both the vessel's fuel consumption and requires more installation space. Parallel hybrid is the most common choice for medium-small units, where the available space is limited, annual operating hours rarely reach high values (5,000 hours), and comfort and relaxation are the user's priorities.

Arranging a preliminary design and operational parameters study phase and analysis is crucial to determine the best possible technological solution in terms of performance, layout, and efficiency. **This is the favorite work of our Hybrid Architects.**

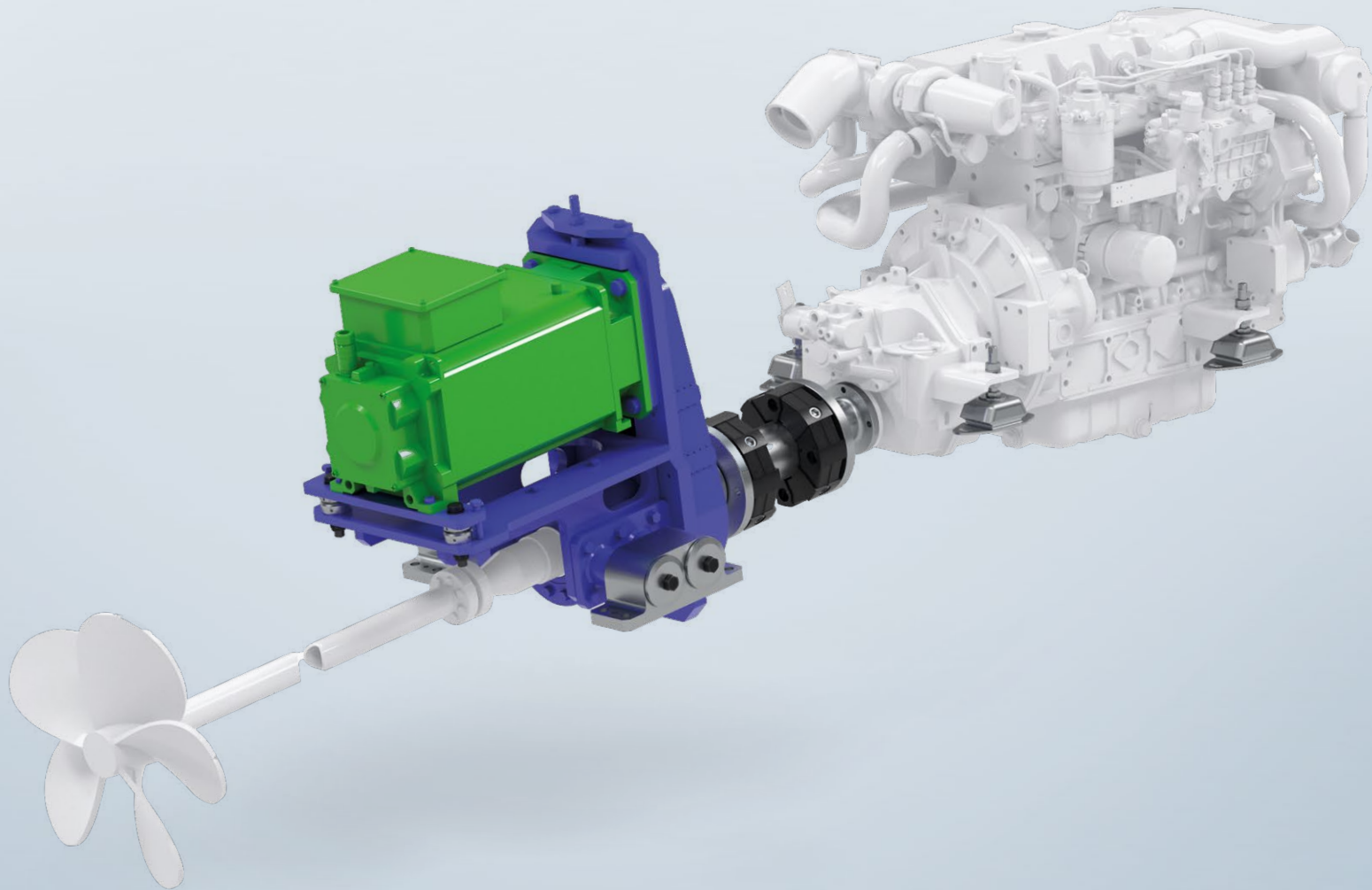

VHD (VULKAN Hybrid Drive) is an integrated hybrid transmission from Gearbox output featuring misalignment coupling, electric machine on bracket with mounts and thrust bearing to propeller shaft. This VHD parallel hybrid system has been designed, realized and installed on BIIM vessel.

It has been working well since spring 2023. This unique design is very compact and does not need to move engine and gearbox, not only good for newbuilding but also retrofitting.

HYBRID DRIVES BY VULKAN



VHD (VULKAN HYBRID DRIVE) | OPERATION MODES | POWER FLOWS

Electric mode ON – ZERO EMISSIONS

When the operator selects the electric mode, the marine gearbox is set on neutral and the e-machine drives the propeller shaft directly through the VULKAN Hybrid Drive device. The diesel engine can be switched off.

ELECTRIC MODE gearbox in neutral

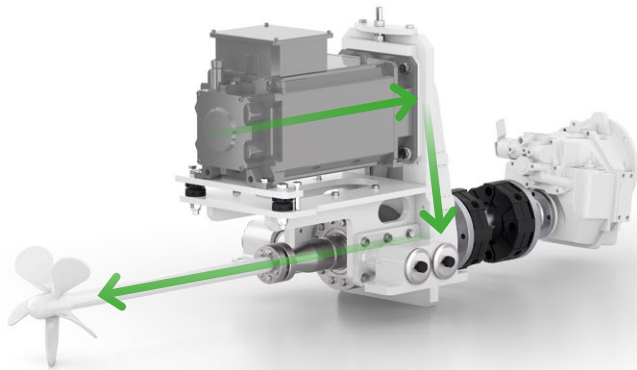

Electric mode power flow

Zero-emission navigation – the electric engine is powered by the batteries; diesel engine is switched off

Diesel mode ON – POWER GENERATION

Selecting the diesel mode button, the marine gearbox will engage the forward. The propulsion will turn in a standard diesel driven propulsion. In this navigation mode the e-machine can be used as a shaft generator to feed the onboard electric demand and/or recharge batteries.

GENERATOR MODE gearbox engaged

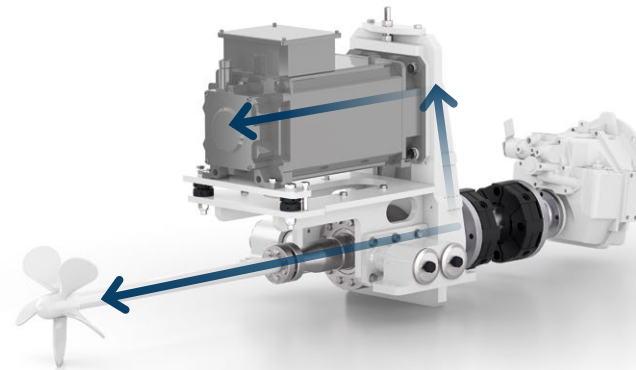

Diesel mode power flow

Electric machines act as variable speed generators recharging the batteries and supplying power to the hotel load

HYBRID DRIVES BY VULKAN



H SERIES

H2000 - SAE1/0/00

coming soon.



H1000 - SAE1/0

coming soon in April 2025

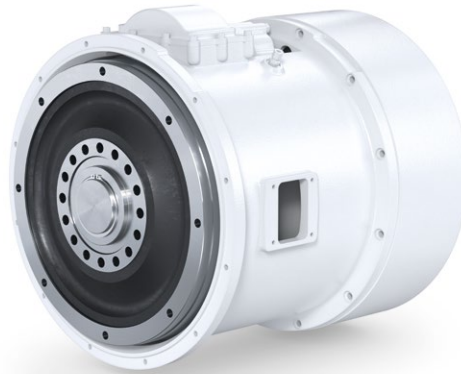

H400 - SAE3/1



Hybrid Module	Dimension	Clutch Torque Capability	E-machine Nom. Power	E-machine Nom. Speed	E-machine Nom. Torque	Weight
	[mm]	[Nm]	[kW]	[rpm]	[Nm]	[kg]
H2000 - SAE1/0//00	790 (SAE00) x 600 mm (D X L)	Up to 10.000	300	1200 (Max speed 2500)	2300	750
H1000 - SAE1/0/	560 SAE1) x 550 mm (D X L)	Up to 6.000	200	2000 (Max speed 2600)	954	430
H400 - SAE3/1	450 SAE3) x 480 mm (D X L)	Up to 2.000	84	2000	400	280



PRODUCT DESIGN AND SUPPLY: HYBRID MODULES

H SERIES HYBRID MODULE

The H Series has been designed to provide a fully integrated system made of mechanical and power management packages.

The H Series hybrid module is supplied with all the components required for hybrid propulsion, ensuring superior quality and reliability compared to a conventional propulsion system.

VULKAN provides the mechanical interfaces specially selected by means of rigid-body dynamic analysis and torsional vibration analysis. Its compactness makes it suitable for machine rooms with limited space, while its robustness and modularity ensure stable performance over time and ease of customisation to meet specific project and customer requirements. The system is particularly suitable for both, new builds and retrofits of vessels already in service.

The design objective behind the product, aimed at optimising space and weight, allows the advantages of hybrid propulsion to be exploited without the need for significant structural modifications.

Besides H series hybrid module package, VULKAN offers its customers a complete turnkey package which includes the following components and their integration:

DRIVETRAIN PACKAGE:

- ⊕ Highly flexible coupling
- ⊕ Electromagnetic clutch
- ⊕ Electric machine
- ⊕ Mechanical integration

POWER DISTRIBUTION AND MANAGEMENT SYSTEM

- ⊕ PMS/SEMS control panel
- ⊕ Throttle Lever System
- ⊕ Battery pack
- ⊕ DC/DC converter
- ⊕ 750 VDC switchboard
- ⊕ Transformer
- ⊕ Inverter panel (VFD)

Batteries:

Air-cooled or liquid-cooled, LFP, registry approved

System commissioning performed by VULKAN





INNOVATIVE SHIP CONCEPT WITH HYBRID DRIVE

Project name: Battello Ibrido Innovativo Modulare (BIIM)

The project was preceded by the winning of a European tender co-financed by the European Regional Development Fund 2014-2020 and managed by Filse - Liguria Region.

Project partners: Dufenco Engineering, VULKAN Italia, Names, Costruzioni Navali Tigullio Castagnola, BluEnergy Revolution e I.Mar.s

Basic idea: The basic idea is the realization of a diesel-electric hybrid drive system with the following characteristics:

- ⌚ Modular and scalable, depending on the different requirements of the ships and their design
- ⌚ Compact system for an innovative and sustainable sailing

These are both features that make it easy to convert the traditional diesel drive to a hybrid drive, even on existing boats. Based on the expected boat characteristics, as a small prototype and with the aim of traveling up to twelve knots, VULKAN's Hybrid Architect Team investigated a parallel hybrid propulsion solution.

Challenge: Construction of a harbor vessel equipped with a hybrid propulsion system, managed by the Consorzio Golfo dei Poeti and used as a test platform for the various technologies on board in the Mediterranean.

Solution: VULKAN has designed an innovative diesel-electric propulsion system for the vessel that allows both, a traditional diesel propulsion (2x100kW diesel engines) and a fully electric propulsion mode (2x30kW electric motors). The innovation is at the heart of the entire project: The two electric motors are powered by salt batteries and fuel cells.

Advantages: The system enables a dual operating mode in addition to the traditional diesel drive: all-electric drive mode with only battery-powered electric motor and conventional diesel drive, with the electric motor acting as a generator that charges the batteries and thus increases the efficiency of the entire system. The all-electric mode guarantees quiet and emission-free operation.

The BIIM was launched in March 2023 and has been in operation in the Mediterranean since then.



The batteries are charged in the harbour

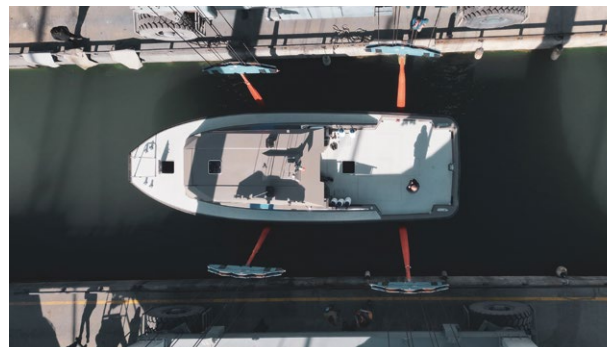

BIIM is ready to sail



The cockpit is functional and clearly laid out

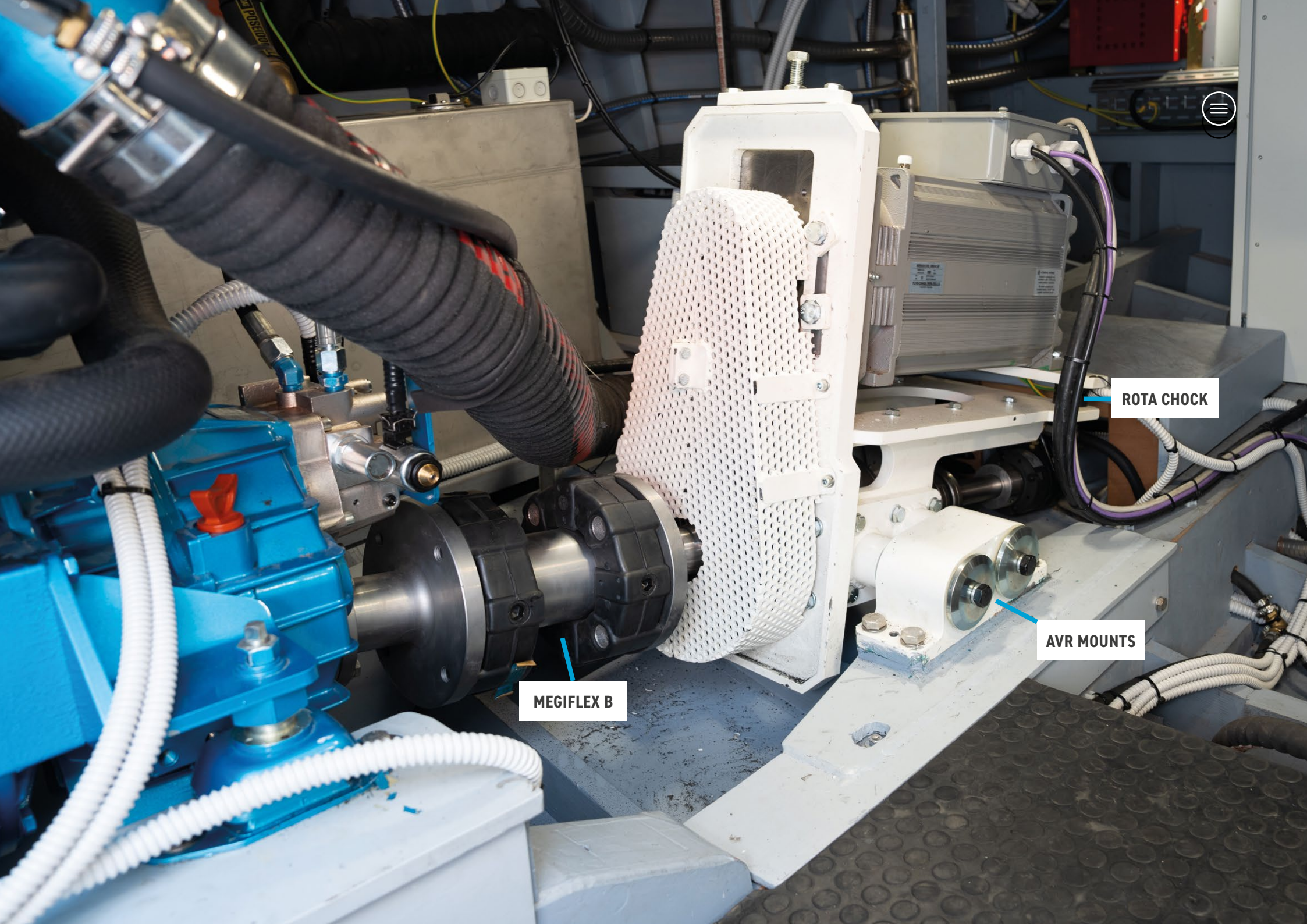

MEGIFLEX B

ROTA CHOCK

AVR MOUNTS

REFERENCE PROJECT | THE BIIM



PRODUCT SUPPLY | INSTALLATION | SERVICE

Technical data of the BIIM

- Length: 13 meters
- Number of passengers: 8
- Maximum speed: 7 (full electric propulsion) to 11 knots
- Range: 4-6 hours

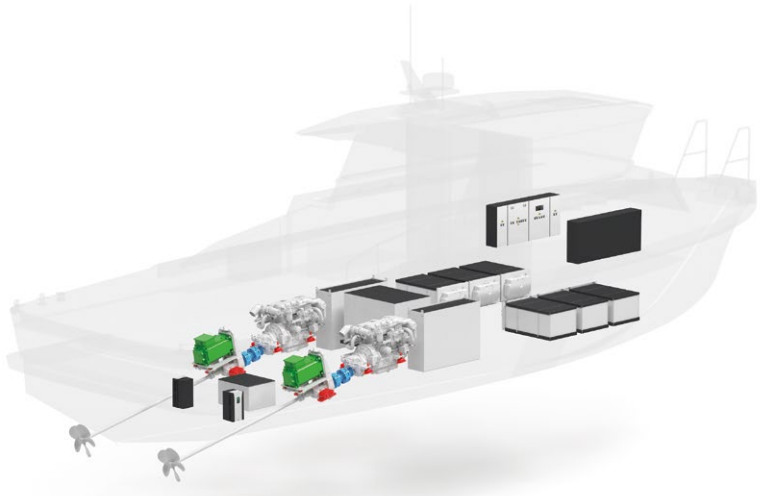
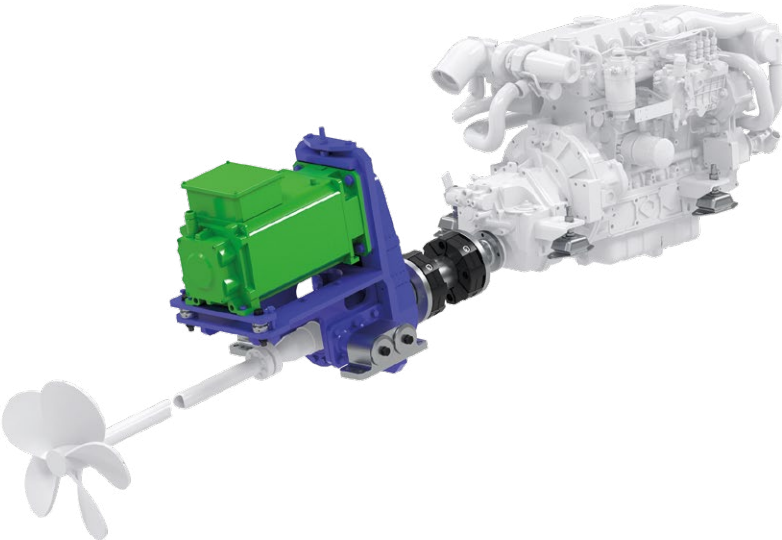

Innovation and sustainability

Castagnola Yacht has developed a composite hull made of wood and natural fibers (100 % recyclable) based on Names' design: The use of natural fibers and resins also makes the external waterproofing (WTS) of the structure environmentally friendly. Salt batteries were chosen (sodium nickel chloride), which are safe because they are non-flammable and 100 % recyclable. The 45 kW PEM fuel cell is supported by a metal hydride system with a 100 kWh hydrogen storage tank, which is also 100 % recyclable.

Watch the video on YouTube



PROGETTO COFINANZIATO DAL FONDO EUROPEO DI SVILUPPO REGIONALE 2014-2020





VE 7967

Actv 2

S. Silvestro





MOTOBATTELLO 3 SERIES 80 CANAL GRANDE ACTV | THE RETROFIT

FROM TRADITIONAL DRIVE TO SERIAL HYBRID

VULKAN is part of a major investment project for sustainable mobility in the Venice lagoon: In collaboration with the local public company for passengers transportation, ACTV, VULKAN Italia has carried out the first conversion of a Canal Grande vessel, series 80, built in 1982.

Customer:
ACTV

Challenge:
The motorboat was built with a traditional propulsion system with a 147 kW engine that guarantees the propeller's propulsion power. This drive was to be replaced by a serial hybrid drive system with the aim of reducing pollutant emissions (NOx, HC, CO, PM).

Solution:
The project comprised the detailed design and structural readjustment of the on-board systems (in particular the serial hybrid system and relevant accessories), the hybrid drive installation and subsequent operational tests and sea-trial.

The new hybrid drive consists of two subsystems:

- 1) Energy generation:
 - ⌚ Power Unit: Consisting of a 125kW diesel engine coupled to an electric generator
 - ⌚ Batteries: 8 LFP battery modules connected to the main switchbol on board via appropriate power converters
- 2) User:
 - ⌚ 147 kW electric motor driving the propulsion line.



LFP battery modules are waterproof and safely housed



Last test before the launch of our first retro-fit ACTV project



The cockpit shines with a new interface



 Actv



212

REFERENCE PROJECT | ACTV PROJECT



MOTOBATTELLO 3 SERIES 80 CANAL GRANDE ACTV | THE RETROFIT

Advantages:

The main advantage of a serial hybrid drive system is to offer considerable flexibility to the drive system, optimizing the combustion engine's performance and improving its efficiency. This flexibility is due to the complete separation between energy sources and consumers, which enables a more efficient management of the energy produced. The new drive system is therefore characterized by the following advantages:

- ⊕ Significantly reduced pollutant emissions (-28 %)
- ⊕ Reduced vibrations
- ⊕ Increased ride comfort

The retrofitted passenger ship was handed over to ACTV and has since been back in passenger service in the ACTV fleet.

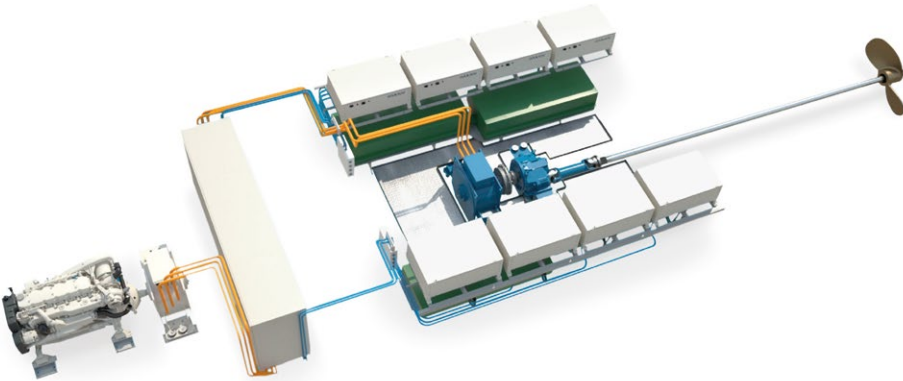

Technical data of the MotoBattello 3	
Length:	23 meters
Number of passengers:	229 max
Maximum speed:	10,8 knots
Field of application:	Passengers transport



Our Hybrid Architect fitter is checking proper installation of the drivetrain.



The fully converted boat can be rolled out





MECHANICAL DESIGN AND INTEGRATION | PRODUCT SUPPLY | INSTALLATION | SERVICE

HIGH COMFORT ON BOARD

Customer:

Admiral Shipyard, Italian Sea Group

Challenge:

VULKAN was involved in the construction of the aluminium megayacht Quinta Essentia and was commissioned with the design of propulsion unit for an advanced hybrid propulsion system.

Solution:

The Quinta Essentia has been equipped with an advanced hybrid propulsion system that integrates two MAN diesel engines of 1,400 horsepower each with two 150 kW electric motors connected to variable-speed power generators. The propulsion line includes, an integrated system interposed between the diesel engine and gearbox that allows the electric motor to be engaged and disengaged via a centrifugal coupling. Power management is realised with an Emerson system that combines hotel service with propulsion. The propulsion unit, which VULKAN has designed, includes T mounts elastic suspension system one layer of (anti-vibration mounts positioned under the machineries and a second layer under the common base-frame), with Propflex T installed on the shaft line, to guarantee the highest standards of comfort on board

Advantages:

The result of the project is a complex system capable of combining the pleasure of sailing electrically in complete silence with a rather sophisticated propulsion system, with great attention to detail, to ensure that the traditional component, diesel engine and mechanical couplings, does not nullify the design effort, resulting in a boat capable of guaranteeing comfort in all conditions of use.

Technical Data of the Quinta Essentia:

Length:	55.0 meters
Beam:	10.20 meters
Draft:	2.45 meters
Tonnage:	851 GT
Speed:	12 knots

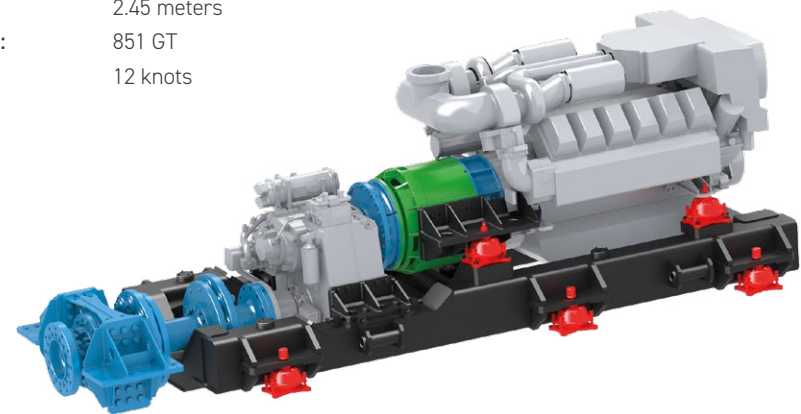





SAILING IN SILENCE

Customer:

Tankoa Yachts

Challenge:

Mechanical integration of a hybrid propulsion system for a 50-metre superyacht built in aluminium.

Solution:

Binta d'Or, powered by Diesel Mtu 4000 8V and E-motion hybrid, features a hybrid system interposed between diesel and gearbox with a 300 kW axial-flow electric motor. Engagement and disengagement of the electric motor via a tooth coupling for maximum passive safety. VULKAN's engineering of the integrated mechanical propulsion system features the propulsion unit installed, via T series flexible mountings, on a skid with a separate Propflex T tail shaft coupling by VULKAN, to ensure the maximum level of structural noise isolation.

Advantages:

The hybrid system enables four different drive modes and offers considerable fuel savings and reduced noise levels.

Technical Data of the Tankoa Binta d'or:

Length:	49.9 meters
Beam:	9.40 meters
Draft:	2.21 meters
Tonnage:	499 GT
Range:	4.000 nm @ 12 knots

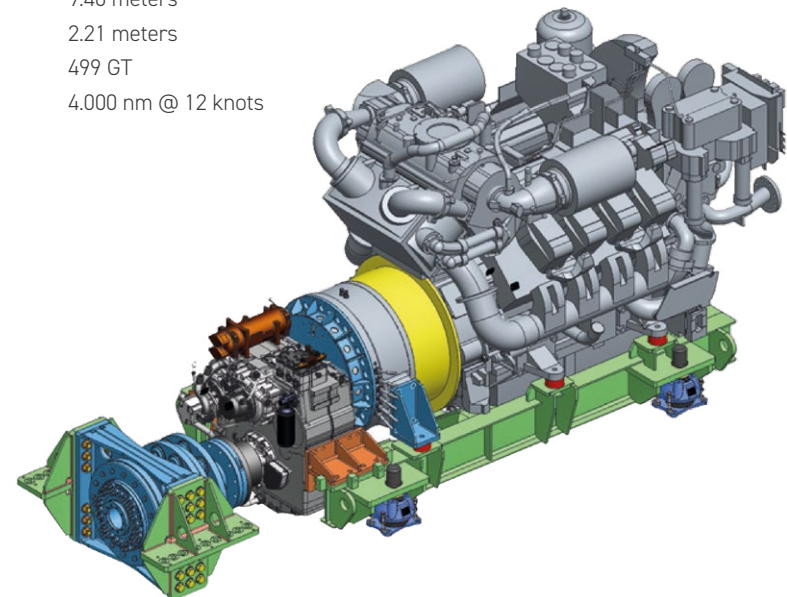





PRODUCT SUPPLY | INSTALLATION | SERVICE

FEELING FREE TO CHOOSE BETWEEN THE PROPULSION SYSTEMS

Customer:

Azimut | Benetti Yachts

Challenge:

VULKAN was involved in another yacht project with another interpretation of hybrid propulsion. The shipyard's objective was to give its customers the choice between a vessel with a traditional propulsion system or a hybrid one, realising the hybrid system with the lowest possible impact in terms of engineering and layout compared to the traditional diesel one.

Solution:

The same components are used in the two vessels' propulsion systems, with the engine and gearbox suspended on elastic mounts on a common base. In the hybrid version, the Siemens 180 kW electric motor is mounted on the PTI of the ZF gearbox, with the mechanical transmission engineered by VULKAN.

Advantages:

Marine hybrid gearboxes enhance fuel efficiency and reduce emissions by combining electric and conventional propulsion methods, leading to lower operational costs and a smaller carbon footprint. They also improve maneuverability, provide redundancy in propulsion systems, and allow for quiet operation, making them ideal for various marine applications.

Technical Data of the Benetti B.Yond:

Length:	36.9 meters
Beam:	8.6 meters
Draft:	2.61 meters
Tonnage:	385 GT
Range:	5.000 nm @ 10 knots

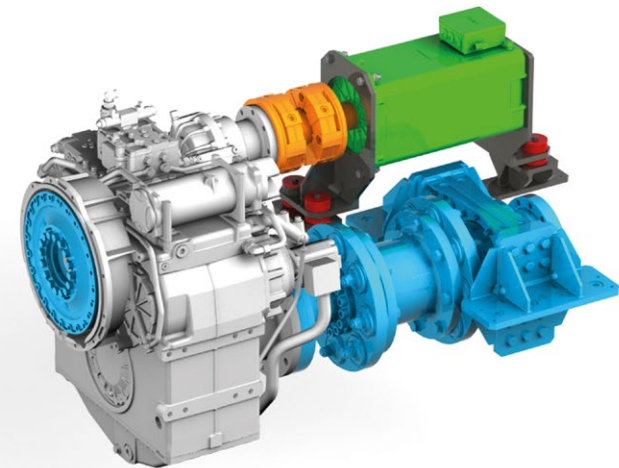

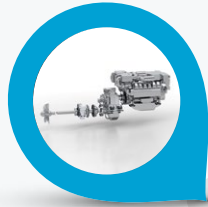

Drivetrain experts

Couplings expertise was not enough. Resilient and anti-shock mounts entered the scene.



More than just flexible

Born to provide reliable couplings for safe sailing.



Vibroacoustic experts

Customers need support with vibrations and noise issues. We are in it from the beginning, analyzing customers' requests and the project with complex models and testing the selected solution at the end.



This is a transition period, especially for propulsion systems. The old, dear diesel engine seems outdated, even in the yachting sector there is a stronger attention about emissions reduction, green, sustainability, new technologies. There is a high demand which comes from many corners; difficult to say which propulsion system will be used in the marine sector in the near future.

Those who say they have many certainties probably have built up their confidence on clay foundations. There are numerous alternatives; many of them still need to be explored. How do we come out of this? With a consultant. Someone who studies and, without prejudice, tries to suggest the best solution for the yard and the owner.

This is what VULKAN has been doing for a long time, this is our philosophy and systematic approach. We started from flexible couplings design and production, the most reliable ones in the naval sector, and we know torsional vibration issues very well. Then we made a step further to be more and more on the customer side: from the beginning, together with naval architects, white sheet and ideas only, up to the end of the project, through retrofitting activities offering a system, not simple products, for noise and vibration control. Hybrid Architect is our latest step in this amazing sailing.



THE VULKAN GROUP

The VULKAN Group, into which the VULKAN company founded in 1889 is integrated today, is composed of three business areas: Marine / Industry and Energy / Refrigeration and Air Conditioning. The VULKAN Group is solely owned by the Hackforth family in the fourth generation.

Our global presence makes it possible for us to provide our customers with fast, customised solutions on site, a decisive competitive advantage. Our 1,800 employees work at 18 sites around the world; our customers can also find a personal contact in our VULKAN agencies covering 51 countries. For our customers this means that our specialists and the matching solutions are quickly available right where they are needed.



- 5 Production sites
- 18 Operating Companies



THE VULKAN GROUP

MARINE HYBRID AND ELECTRIC APPLICATION

VULKAN's flexible couplings and mounts are used on nearly all types of ships with diesel mechanic, hybrid or electric drive concepts. Large cruise ships such as the AIDAstella, workboats such as the ice-breaking drill ship Stena IceMAX or the jack-up vessel Innovation and boats for leisure

activities can all benefit from the outstandingly dynamic properties and the long product lifetime of VULKAN products made in one of our production locations.

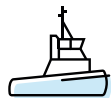

Tugs

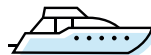

Yachts



Governmental vessels

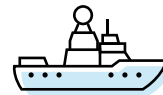

Offshore vessels

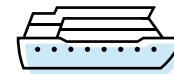

Passenger Ferries



Workboats



VULKAN

VULKAN

VULKAN

olke

SERVICE YOU CAN TRUST



COMPLETE COMPETENCE FOR YOUR SYSTEM

Certified After Sales service from the manufacturer.

Our worldwide service offerings extend beyond just new product sales are characterized by the high level of competence of our employees. Our teams consist of experienced specialists from our industry; highly trained mechanics, technicians and engineers are here to assist you on a personal level for all your necessary repairs, system optimizations, conversions and regular inspections.

At **VULKAN** we hold ourselves to the highest standards so that we can perform for you day in and day out. Innovative and custom designed and developed monitoring systems enable us to monitor the installed couplings around the clock. These systems offer several distinct advantages: Failure avoidance, early detection of rapid changes in the system operation, as well as the prolonged service life of our products. To fully support you we have fast delivery of spare parts, offer customer-tailored training seminars geared towards the individual needs of our customers, state-of-the-art measurement analysis and troubleshooting, as well as maintenance contracts, along with a 24/7 hotline to round out the **VULKAN** After Sales services.

Benefit from low costs and reliable availability through high-quality, class approved couplings in conjunction with certified service directly from us, the manufacturer – the world market leader!

It's a small world.

Our experienced service team is available 24 hours a day and will be on site for you as quickly as possible if necessary.

In order to support you as a trustworthy and competent partner and to minimize machine downtimes and operational interruptions, we offer a comprehensive range of After Sales services for our products.

The VULKAN emergency service is ready for action at any time with the following scope of services:

- ⊕ Rapid damage assessment on site
- ⊕ Fast and efficient spare parts supply
- ⊕ Emergency repairs on site, on board... anywhere
- ⊕ Installation of spare parts
- ⊕ Comprehensive troubleshooting support for detecting system-related faults

VULKAN 24/7 hotline:

+49 178 892 2179

Publisher: VULKAN Group

Concept and Design: Hackforth Holding GmbH & Co. KG . VULKAN Marketing . Heerstraße 66, 44653 Herne / Germany . E-mail: marketing@vulkan.com

Status: 09/2024. All duplication, reprinting and translation rights are reserved. Any changes due to the technological progress are reserved. For questions or queries please contact VULKAN.